

FEATURES   **DRY ONLY**

ELECTRICAL

LIGHT DIRECTION: Downward
LAMPING: One LED or Incandescent Lamp (Sold Separately)
WATTS PER LAMP: 75W Max
TOTAL WATTAGE: 75W Max
LAMP BASE: Medium Base (E26)
VOLTAGE: 120V

DIMMING

DIMMING: Dimmable (Lamp Dependent)

OPTICS

NONE (BARE LED)

CONSTRUCTION

FIXTURE MATERIAL: Steel

DIMENSIONS

3 1/8" H x 2 3/8" Dia.

COLORS/FINISHES

FINISH: Beautifully and evenly finished with brushed nickel. Feel at ease with nickel's lasting quality and stunning appearance, brushed to perfect symmetry by skilled craftsmen. High-quality nickel provides durability and an attractive gleam.
ELECTRICAL CORD: Clear with Silver Wire

INSTALLATION

CEILING SURFACE MOUNTING:

- 10 ft. Adjustable Electrical Cord
- Mounting Canopy and Hardware Included
- Mounts Onto Standard Ceiling J-Box
- Suitable for Indoor Use Only

COMPATIBLE SHADES

See Compatible *QuantaLight Mix & Match Series* Specification Sheets

- 0020 Fabric Drum Shades
- 0025 Large Fabric Cylinder Shades
- 0027 Extra Large Fabric Cylinder Shades
- 0053-6 Acrylic Cylinder Shade
- GS-230s/500s/780 Glass Dome Shades
- GS-300s/10s Glass Tube Cylinder Shades
- GS-540s/50s/60s Glass Vase Shades
- GS-553 Glass Beehive Shade
- GS-790s Glass Cylinder Shades

COMPLIANCES

 **cULus LISTED**
DRY LOCATIONS ONLY

WARRANTY

 **1-YEAR LIMITED WARRANTY**



Catalog #:
 Type:
 Project:
 Prepared By:

AT A GLANCE
 Bare mini pendant features an extensive selection of shades (sold separately). Quickly and easily customize the perfect fixture for your project by pairing to any compatible *QuantaLight Mix & Match* shade. Ideal for a variety of applications such as bars, restaurants, kitchen islands, and over dining tables. Finished in a beautiful contemporary brushed nickel.

ORDER CONFIGURATOR

The pendant product catalog code is prefilled for your convenience below (e.g., Pendant #: 2421-33). To order compatible *QuantaLight Mix & Match* pendant shades, use the corresponding specification sheet(s) for the desired compatible *QuantaLight Mix & Match Series*.

PENDANT

2421 - **33**

PENDANT MODEL **FINISH**

2421 33 Brushed Nickel

QUICK VIEW

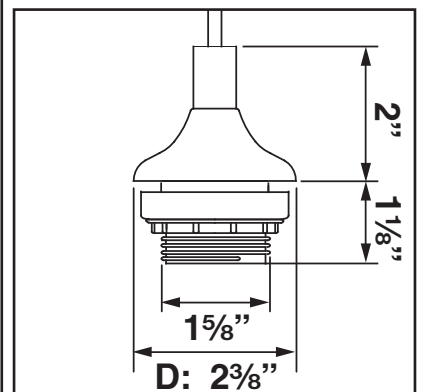
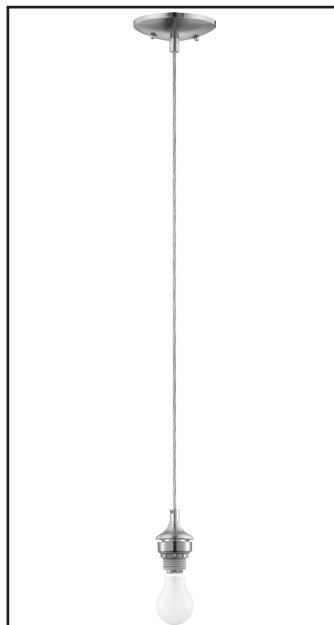

FEATURES **DRY ONLY**

DIRECTION

LIGHT DIRECTION: Downward

DIMENSIONS

10" H x 10" Dia.

CONSTRUCTION/COLORS

DRUM-SHAPED SHADES:

Versatile palette of soft, natural colors complements interiors beautifully. Linen or basketweave is strong and resistant to wear.

- Deep Black Finely Woven Fabric
- Brown Basketweave
- Beige Handcrafted Linen
- Ecru Linen

INSTALLATION

BARE PENDANT MOUNTING:

- Mounts Onto Compatible *QuantaLight* Bare Pendants (See Below)
- Suitable for Indoor Use Only

COMPATIBLE PENDANTS

See Compatible *QuantaLight* Bare Pendant Specification Sheets

- *QuantaLight* 2429-33 Brushed Nickel Integrated LED Mini Pendant
- *QuantaLight* 2421-33 Brushed Nickel Standard Medium Base (E26) Mini Pendant
- *QuantaLight* 2421-79 Antique Bronze Standard Medium Base (E26) Mini Pendant

COMPLIANCES

DRY ONLY DRY LOCATIONS ONLY



Catalog #:

Type:

Project:

Prepared By:

AT A GLANCE

These fabric drum shades from the *QuantaLight Mix & Match Series* feature an assortment of stylish textiles. Quickly and easily customize the perfect fixture for your project by pairing any of these shades to a compatible *QuantaLight* bare pendant. Ideal for a variety of applications such as bars, restaurants, kitchen islands, and over dining tables. This versatile palette of soft, natural colors complements interiors beautifully. Linen or basketweave is strong and resistant to wear. Measures 10" H x 10" D.

ORDER CONFIGURATOR

To order, select one option from each table column to configure the desired shade product catalog code. Then, fill in the boxes below (e.g., Shade #: 0020-34). To order compatible pendant(s), use the corresponding specification sheet(s) for the desired compatible *QuantaLight* bare pendant(s).

SHADE #

0020	
------	--

SHADE MODEL	FABRIC
-------------	--------

- 0020 5
Deep Black Finely Woven Fabric
- 29 Brown Basketweave
- 34 Beige Handcrafted Linen
- 40 Ecru Linen

QUICK VIEW



0020-5



0020-29



0020-34



0020-40

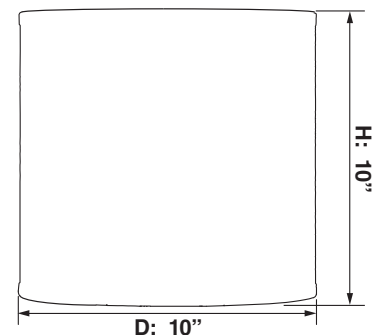



FEATURES **DRY ONLY**

DIRECTION

LIGHT DIRECTION: Downward

DIMENSIONS

12" H x 6" Dia.

CONSTRUCTION/COLORS

CYLINDER-SHAPED SHADES:

Versatile palette of soft, natural colors complements interiors beautifully. Linen or basketweave is strong and resistant to wear.

- Deep Black Finely Woven Fabric
- Brown Basketweave
- Beige Handcrafted Linen
- Ecru Linen

INSTALLATION

BARE PENDANT MOUNTING:

- Mounts Onto Compatible *QuantaLight* Bare Pendants (See Below)
- Suitable for Indoor Use Only

COMPATIBLE PENDANTS

See Compatible *QuantaLight* Bare Pendant Specification Sheets

- *QuantaLight* 2429-33 Brushed Nickel Integrated LED Mini Pendant
- *QuantaLight* 2421-33 Brushed Nickel Standard Medium Base (E26) Mini Pendant
- *QuantaLight* 2421-79 Antique Bronze Standard Medium Base (E26) Mini Pendant

COMPLIANCES

DRY ONLY DRY LOCATIONS ONLY

Catalog #:

Type:

Project:

Prepared By:

AT A GLANCE

These large fabric cylinder shades from the *QuantaLight Mix & Match Series* feature an assortment of stylish textiles. Quickly and easily customize the perfect fixture for your project by pairing any of these shades to a compatible *QuantaLight* bare pendant. Ideal for a variety of applications such as bars, restaurants, kitchen islands, and over dining tables. This versatile palette of soft, natural colors complements interiors beautifully. Linen or basketweave is strong and resistant to wear. Measures 12" H x 6" D.

ORDER CONFIGURATOR

To order, select one option from each table column to configure the desired shade product catalog code. Then, fill in the boxes below (e.g., Shade #: 0025-34). To order compatible pendant(s), use the corresponding specification sheet(s) for the desired compatible *QuantaLight* bare pendant(s).

SHADE #

0025	
------	--

SHADE MODEL	STYLE
-------------	-------

- | | |
|------------------------------------------|--------------------------------|
| <input checked="" type="checkbox"/> 0025 | <input type="checkbox"/> 5 |
| | Deep Black Finely Woven Fabric |
| | <input type="checkbox"/> 29 |
| | Brown Basketweave |
| | <input type="checkbox"/> 34 |
| | Beige Handcrafted Linen |
| | <input type="checkbox"/> 40 |
| | Ecru Linen |

QUICK VIEW

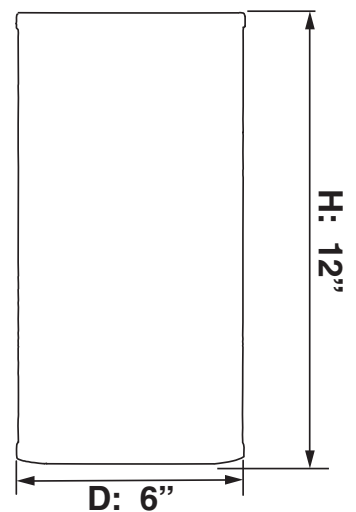



FEATURES **DRY ONLY**

DIRECTION

LIGHT DIRECTION: Downward

DIMENSIONS

20" H x 10" Dia.

CONSTRUCTION/COLORS

CYLINDER-SHAPED SHADES:

Versatile palette of soft, natural colors complements interiors beautifully. Linen or basketweave is strong and resistant to wear.

- Deep Black Finely Woven Fabric
- Brown Basketweave
- Beige Handcrafted Linen
- Ecru Linen

INSTALLATION

BARE PENDANT MOUNTING:

- Mounts Onto Compatible *QuantaLight* Bare Pendants (See Below)
- Suitable for Indoor Use Only

COMPATIBLE PENDANTS

See Compatible *QuantaLight* Bare Pendant Specification Sheets

- *QuantaLight* 2429-33 Brushed Nickel Integrated LED Mini Pendant
- *QuantaLight* 2421-33 Brushed Nickel Standard Medium Base (E26) Mini Pendant
- *QuantaLight* 2421-79 Antique Bronze Standard Medium Base (E26) Mini Pendant

COMPLIANCES

DRY ONLY DRY LOCATIONS ONLY

Catalog #:

Type:

Project:

Prepared By:

AT A GLANCE

These extra large fabric cylinder shades from the *QuantaLight Mix & Match Series* feature an assortment of stylish textiles. Quickly and easily customize the perfect fixture for your project by pairing any of these shades to a compatible *QuantaLight* bare pendant. Ideal for a variety of applications such as bars, restaurants, kitchen islands, and over dining tables. This versatile palette of soft, natural colors complements interiors beautifully. Linen or basketweave is strong and resistant to wear. Measures 20" H x 10" D.

ORDER CONFIGURATOR

To order, select one option from each table column to configure the desired shade product catalog code. Then, fill in the boxes below (e.g., Shade #: 0027-34). To order compatible pendant(s), use the corresponding specification sheet(s) for the desired compatible *QuantaLight* bare pendant(s).

SHADE #

0027	
------	--

SHADE MODEL	STYLE
-------------	-------

- | | |
|------------------------------------------|--------------------------------|
| <input checked="" type="checkbox"/> 0027 | <input type="checkbox"/> 5 |
| | Deep Black Finely Woven Fabric |
| | <input type="checkbox"/> 29 |
| | Brown Basketweave |
| | <input type="checkbox"/> 34 |
| | Beige Handcrafted Linen |
| | <input type="checkbox"/> 40 |
| | Ecru Linen Shade |

QUICK VIEW

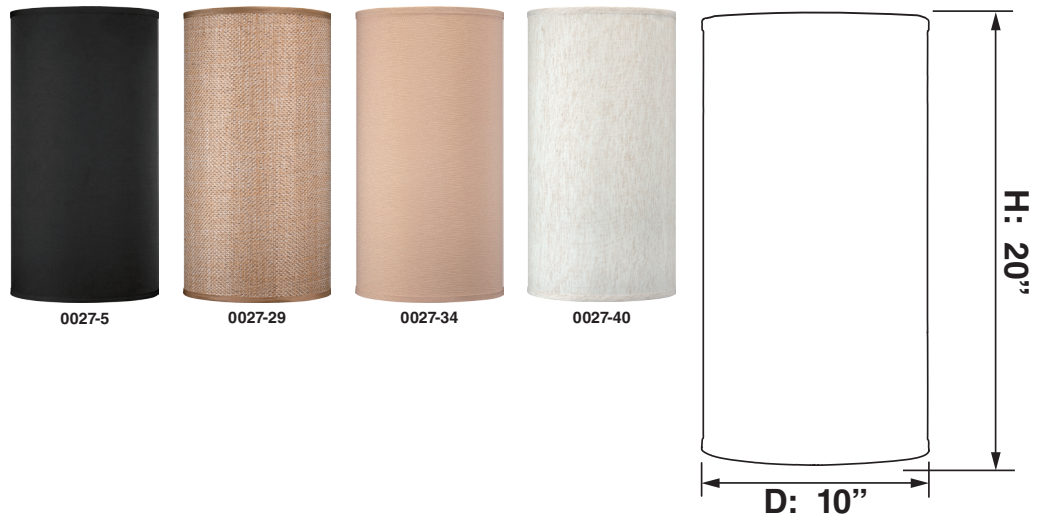

FEATURES **DRY ONLY**

DIRECTION

LIGHT DIRECTION: Downward

DIMENSIONS

12" H x 5½" Dia.

CONSTRUCTION/COLORS

HANDCRAFTED CYLINDER-SHAPED

SHADE: White acrylic diffuses light evenly and features a simple, minimalist look.

INSTALLATION

BARE PENDANT MOUNTING:

- Mounts Onto Compatible *QuantaLight* Bare Pendant (See Below)
- Suitable for Indoor Use Only

COMPATIBLE PENDANTS

See Compatible *QuantaLight* Bare Pendant Specification Sheets

- *QuantaLight* 2429-33 Brushed Nickel Integrated LED Mini Pendant
- *QuantaLight* 2421-33 Brushed Nickel Standard Medium Base (E26) Mini Pendant
- *QuantaLight* 2421-79 Antique Bronze Standard Medium Base (E26) Mini Pendant

COMPLIANCES

DRY ONLY DRY LOCATIONS ONLY

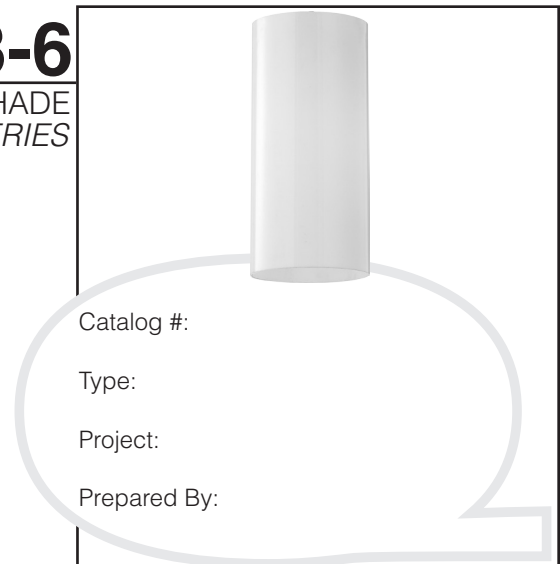

Catalog #:

Type:

Project:

Prepared By:

AT A GLANCE

This acrylic cylinder shade from the *QuantaLight Mix & Match Series* diffuses light evenly and features a simple, minimalist look. Quickly and easily customize the perfect fixture for your project by pairing this shade to a compatible *QuantaLight* bare pendant. Ideal for a variety of applications such as bars, restaurants, kitchen islands, and over dining tables. Measures 12" H x 5½" D.

ORDER CONFIGURATOR

The shade product catalog code is prefilled for your convenience below (e.g., Shade #: 0053-6). To order compatible pendant(s), use the corresponding specification sheet(s) for the desired compatible *QuantaLight* bare pendant(s).

SHADE #

0053	-	6
SHADE MODEL		COLOR
<input checked="" type="checkbox"/> 0053		<input checked="" type="checkbox"/> 6 White

QUICK VIEW

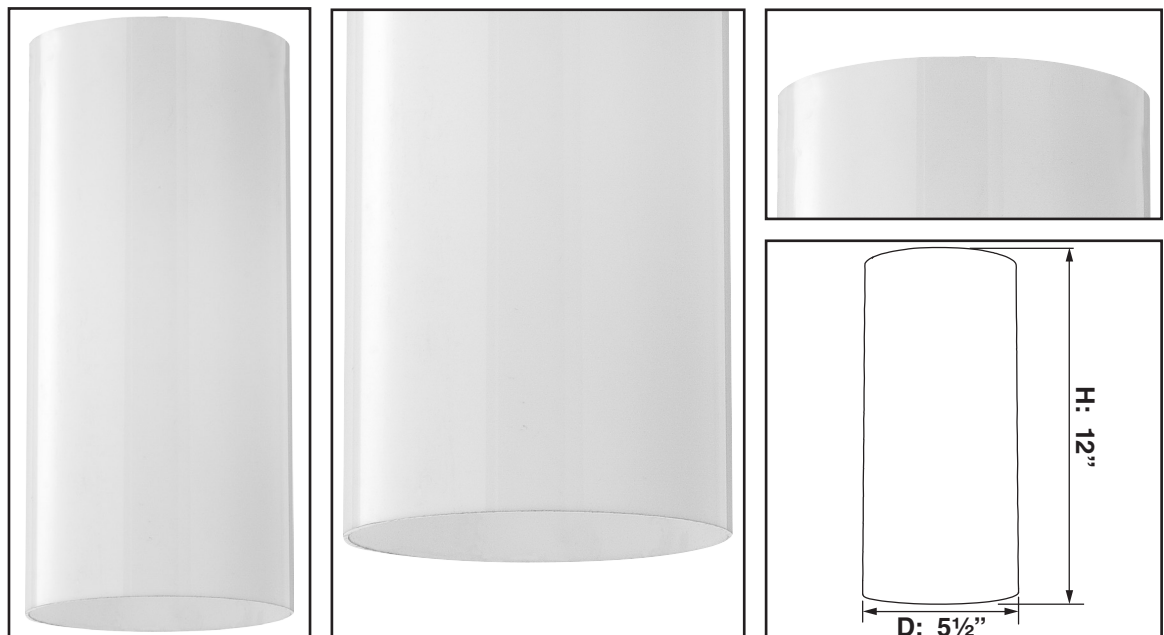

QuantaLight™ GS-230s/500s/780

SPECIFICATION SHEET

GLASS DOME SHADES
MIX & MATCH SERIES

FEATURES **DRY ONLY**

DIRECTION

LIGHT DIRECTION: Downward

DIMENSIONS

6½" H x 5¼" Dia.

CONSTRUCTION/COLORS

HANDCRAFTED DOME-SHAPED SHADES:

Multiple layers diffuse light evenly for exceptionally vibrant color.

- Etched Cased Glass
 - White
 - Amber
- Frit Glass
 - White
 - Amber
- Swirl Glass
 - Amber

INSTALLATION

BARE PENDANT MOUNTING:

- Mounts Onto Compatible *QuantaLight* Bare Pendant (See Below)
- Suitable for Indoor Use Only

COMPATIBLE PENDANTS

See Compatible *QuantaLight* Bare Pendant Specification Sheets

- *QuantaLight* 2429-33 Brushed Nickel Integrated LED Mini Pendant
- *QuantaLight* 2421-33 Brushed Nickel Standard Medium Base (E26) Mini Pendant
- *QuantaLight* 2421-79 Antique Bronze Standard Medium Base (E26) Mini Pendant

COMPLIANCES

DRY ONLY DRY LOCATIONS ONLY

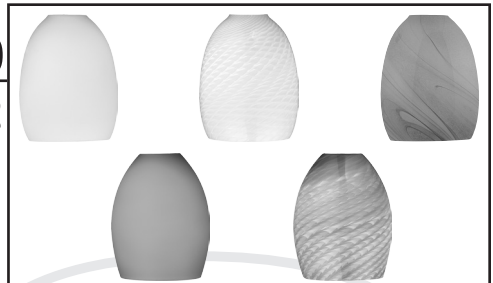

Catalog #:
Type:
Project:
Prepared By:

AT A GLANCE

These glass dome shades from the *QuantaLight Mix & Match Series* feature an assortment of stylish designs. Quickly and easily customize the perfect fixture for your project by pairing any of these shades to a compatible *QuantaLight* bare pendant. Ideal for a variety of applications such as bars, restaurants, kitchen islands, and over dining tables. Beautiful, upscale glass shades are expertly handcrafted with multiple layers by master artisans for exceptionally vibrant color. Measures 6½" H x 5¼" D.

ORDER CONFIGURATOR

To order, select one option from each table column to configure the desired shade product catalog code. Then, fill in the boxes below (e.g., Shade #: GS-500). To order compatible pendant(s), use the corresponding specification sheet(s) for the desired compatible *QuantaLight* bare pendant(s).

SHADE

GS	
----	--

SHADE MODEL	STYLE
-------------	-------

- | | |
|----------------------------------------|--------------------------------------------------------------------------------------------------------------------------------------------------------------------------------------------------------------------------------------------------------------------|
| <input checked="" type="checkbox"/> GS | <input type="checkbox"/> 230 White Etched Cased Glass
<input type="checkbox"/> 233 Amber Etched Cased Glass
<input type="checkbox"/> 500 White Frit Glass
<input type="checkbox"/> 501 Amber Frit Glass
<input type="checkbox"/> 780 Amber Swirl Glass |
|----------------------------------------|--------------------------------------------------------------------------------------------------------------------------------------------------------------------------------------------------------------------------------------------------------------------|

QUICK VIEW

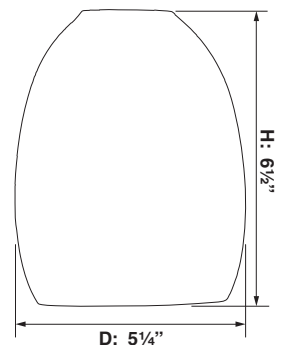
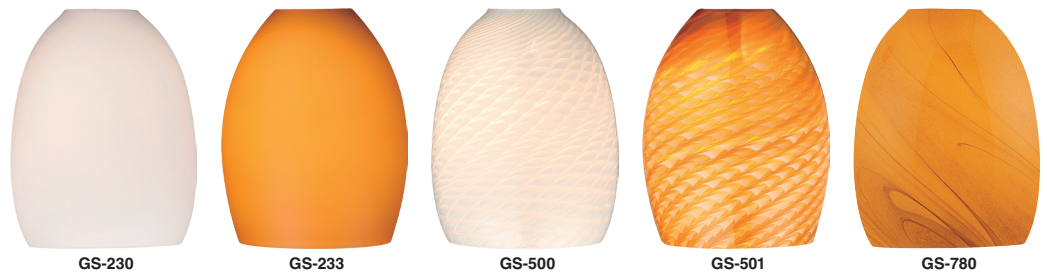

QuantaLight™ GS-300s/10s

SPECIFICATION SHEET GLASS TUBE CYLINDER SHADES
MIX & MATCH SERIES

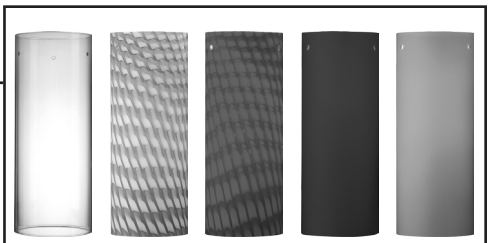

FEATURES **DRY ONLY**

DIRECTION

LIGHT DIRECTION: Downward

DIMENSIONS

8" H x 3" Dia.

CONSTRUCTION/COLORS

HANDCRAFTED CYLINDER-SHAPED

SHADES: Frit and etched cased glass shades have multiple layers and diffuse light evenly for exceptionally vibrant color.

- Clear Glass
- Frit Glass
 - Amber
 - Red
- Etched Cased Glass
 - Red
 - Blue

INSTALLATION

BARE PENDANT MOUNTING:

- Mounts Onto Compatible *QuantaLight* Bare Pendant (See Below)
- Suitable for Indoor Use Only

COMPATIBLE PENDANTS

See Compatible *QuantaLight* Bare Pendant Specification Sheets

- *QuantaLight* 2429-33 Brushed Nickel Integrated LED Mini Pendant
- *QuantaLight* 2421-33 Brushed Nickel Standard Medium Base (E26) Mini Pendant
- *QuantaLight* 2421-79 Antique Bronze Standard Medium Base (E26) Mini Pendant

COMPLIANCES

DRY ONLY DRY LOCATIONS ONLY

Catalog #:

Type:

Project:

Prepared By:

AT A GLANCE

These glass tube cylinder shades from the *QuantaLight Mix & Match Series* feature an assortment of stylish designs. Quickly and easily customize the perfect fixture for your project by pairing any of these shades to a compatible *QuantaLight* bare pendant. Ideal for a variety of applications such as bars, restaurants, kitchen islands, and over dining tables. Beautiful, upscale glass shades are expertly handcrafted with multiple layers by master artisans for exceptionally vibrant color. Measures 8" H x 3" D.

ORDER CONFIGURATOR

To order, select one option from each table column to configure the desired shade product catalog code. Then, fill in the boxes below (e.g., Shade #: GS-310). To order compatible pendant(s), use the corresponding specification sheet(s) for the desired compatible *QuantaLight* bare pendant(s).

SHADE

GS	
----	--

SHADE MODEL	STYLE
-------------	-------

- GS
- 307 Clear Glass
 - 309 Amber Frit Glass
 - 310 Red Frit Glass
 - 313 Red Etched Cased Glass
 - 315 Blue Etched Cased Glass
 - 317 Amber Etched Cased Glass

QUICK VIEW

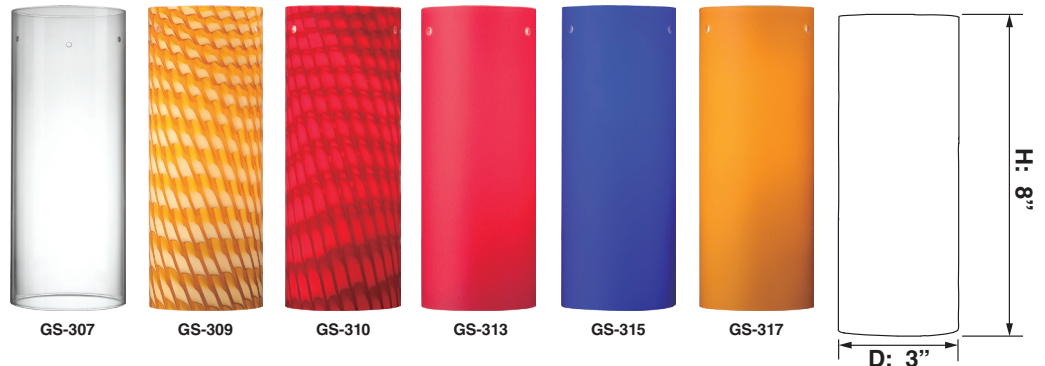

QuantaLight™ GS-540s/50s/60s

SPECIFICATION SHEET

GLASS VASE SHADES
MIX & MATCH SERIES

FEATURES **DRY ONLY**

DIRECTION

LIGHT DIRECTION: Downward

DIMENSIONS

8½" H x 5" Dia.

CONSTRUCTION/COLORS

HANDCRAFTED VASE-SHAPED SHADES:

Multiple layers diffuse light evenly for exceptionally vibrant color.

- Frit Glass
 - White
 - Amber
 - Red
- Etched Cased Glass
 - White
 - Red
 - Blue
 - Amber
- Alabaster Glass
 - White
- Specialty Glass
 - Eggshell (White)
 - Scribble (White with Black Lines)
 - Dragon Scale (Light Brown)
 - Lava (Orange with Infused Red, Yellow, Purple, and Green)
 - Zebra Jasper (Brown with Infused Black Green, Yellow, and Purple)
 - Light Spiral (White with Clear Spiraling Lines)
 - Ore (Deep Brown)
 - Whirlwind (Clear with Spiraling White Glass)

INSTALLATION

BARE PENDANT MOUNTING:

- Mounts Onto Compatible *QuantaLight* Bare Pendant (See Below)
- Suitable for Indoor Use Only

COMPATIBLE PENDANTS

See Compatible *QuantaLight* Bare Pendant Specification Sheets

- *QuantaLight* 2429-33 Brushed Nickel Integrated LED Mini Pendant
- *QuantaLight* 2421-33 Brushed Nickel Standard Medium Base (E26) Mini Pendant
- *QuantaLight* 2421-79 Antique Bronze Standard Medium Base (E26) Mini Pendant

COMPLIANCES

DRY ONLY DRY LOCATIONS ONLY

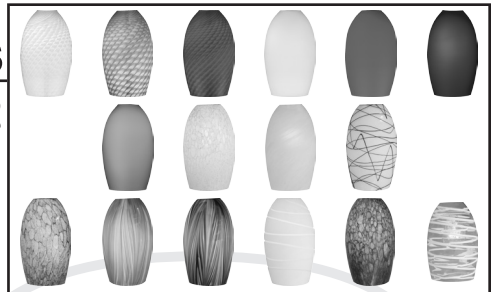

Catalog #:

Type:

Project:

Prepared By:

AT A GLANCE

These glass vase shades from the *QuantaLight Mix & Match Series* feature an assortment of stylish designs. Quickly and easily customize the perfect fixture for your project by pairing any of these shades to a compatible *QuantaLight* bare pendant. Ideal for a variety of applications such as bars, restaurants, kitchen islands, and over dining tables. Beautiful, upscale glass shades are expertly handcrafted with multiple layers by master artisans for exceptionally vibrant color. Measures 8½" H x 5" D.

ORDER CONFIGURATOR

To order, select one option from each table column to configure the desired shade product catalog code. Then, fill in the boxes below (e.g., Shade #: GS-549). To order compatible pendant(s), use the corresponding specification sheet(s) for the desired compatible *QuantaLight* bare pendant(s).

SHADE

GS	
-----------	--

SHADE MODEL	STYLE
-------------	-------

- GS
- 540 White Frit Glass
 - 541 Amber Frit Glass
 - 542 Red Frit Glass
 - 543 White Etched Cased Glass
 - 545 Red Etched Cased Glass
 - 546 Blue Etched Cased Glass
 - 547 Amber Etched Cased Glass
 - 549 Eggshell
 - 551 White Alabaster Glass
 - 555 Scribble
 - 556 Dragon Scale
 - 557 Lava
 - 558 Zebra Jasper
 - 559 Light Spiral
 - 560 Ore
 - 562 Whirlwind

QUICK VIEW

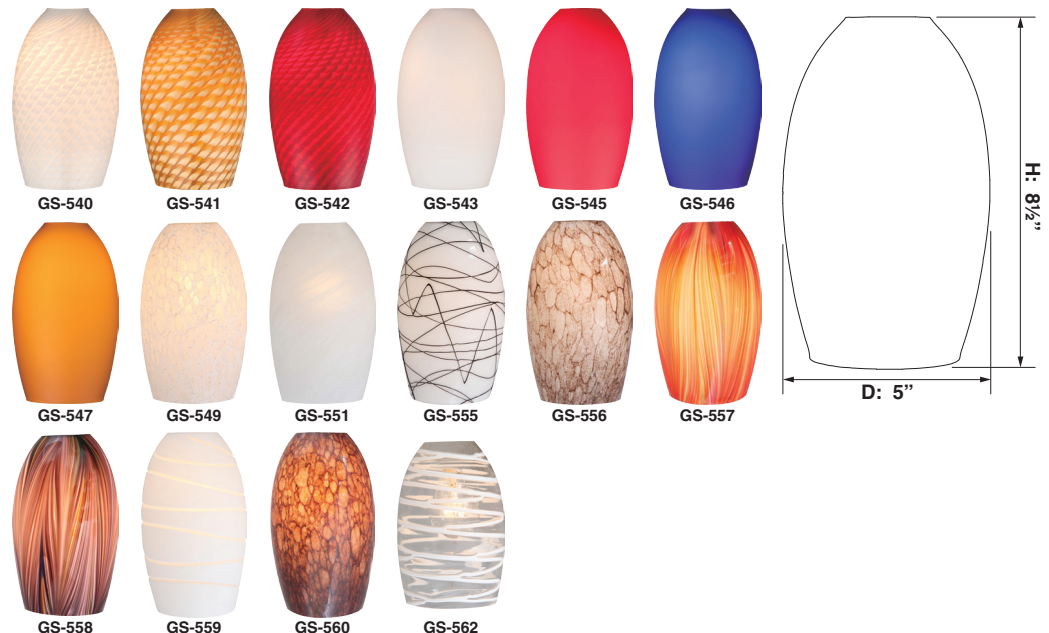



FEATURES **DRY ONLY**

DIRECTION

LIGHT DIRECTION: Downward

DIMENSIONS

6½" H x 10" Dia.

CONSTRUCTION/COLORS

HANDCRAFTED BEEHIVE-SHAPED

SHADE: Clear Glass with Inky Black Swirls

INSTALLATION

BARE PENDANT MOUNTING:

- Mounts Onto Compatible *QuantaLight* Bare Pendant Pendants (See Below)
- Suitable for Indoor Use Only

COMPATIBLE PENDANTS

See Compatible *QuantaLight* Bare Pendant Specification Sheets

- *QuantaLight* 2429-33 Brushed Nickel Integrated LED Mini Pendant
- *QuantaLight* 2421-33 Brushed Nickel Standard Medium Base (E26) Mini Pendant
- *QuantaLight* 2421-79 Antique Bronze Standard Medium Base (E26) Mini Pendant

COMPLIANCES

DRY ONLY DRY LOCATIONS ONLY

Catalog #:

Type:

Project:

Prepared By:

AT A GLANCE

This clear glass beehive shade from the *QuantaLight Mix & Match Series* features a unique ink-in-water effect. Quickly and easily customize the perfect fixture for your project by pairing this shade to a compatible *QuantaLight* bare pendant. Ideal for a variety of applications such as bars, restaurants, kitchen islands, and over dining tables. Beautiful, upscale glass shade is expertly handcrafted by master artisans. Measures 6½" H x 10" D.

ORDER CONFIGURATOR

The shade product catalog code is prefilled for your convenience below (e.g., Shade #: GS-533). To order compatible pendant(s), use the corresponding specification sheet(s) for the desired compatible *QuantaLight* bare pendant(s).

SHADE #

GS	553
-----------	------------

SHADE MODEL	STYLE
--------------------	--------------

- GS** **553** Clear Glass Beehive Shade with Inky Black Swirls

QUICK VIEW

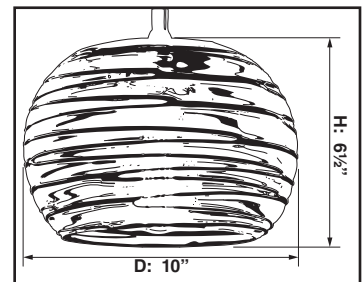
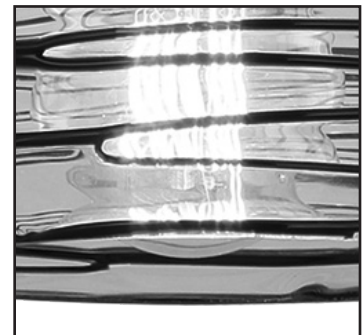



FEATURES **DRY ONLY**

DIRECTION

LIGHT DIRECTION: Downward

DIMENSIONS

6" H x 4" Dia.

CONSTRUCTION/COLORS

HANDCRAFTED SMALL CYLINDER-SHAPED SHADES:

Multiple layers diffuse light evenly.

- Etched Cased Glass
 - White
- Frit Glass
 - White
- Sepia Glass

INSTALLATION

BARE PENDANT MOUNTING:

- Mounts Onto Compatible *QuantaLight* Bare Pendants (See Below)
- Suitable for Indoor Use Only

COMPATIBLE PENDANTS

See Compatible *QuantaLight* Bare Pendant Specification Sheets

- *QuantaLight* 2429-33 Brushed Nickel Integrated LED Mini Pendant
- *QuantaLight* 2421-33 Brushed Nickel Standard Medium Base (E26) Mini Pendant
- *QuantaLight* 2421-79 Antique Bronze Standard Medium Base (E26) Mini Pendant

COMPLIANCES

DRY ONLY DRY LOCATIONS ONLY

Catalog #:

Type:

Project:

Prepared By:

AT A GLANCE

These glass cylinder shades from the *QuantaLight Mix & Match Series* feature an assortment of elegant designs. Quickly and easily customize the perfect fixture for your project by pairing any of these shades to a compatible *QuantaLight* bare pendant. Ideal for a variety of applications such as bars, restaurants, kitchen islands, and over dining tables. Beautiful, upscale glass shades are expertly handcrafted by master artisans. Measures 6" H x 4" D.

ORDER CONFIGURATOR

To order, select one option from each table column to configure the desired shade product catalog code. Then, fill in the boxes below (e.g., Shade #: GS-792). To order compatible pendant(s), use the corresponding specification sheet(s) for the desired compatible *QuantaLight* bare pendant(s).

SHADE #

GS	
-----------	--

SHADE MODEL	STYLE
-------------	-------

- GS
- 791 Etched White Cased Glass
- 792 White Frit Glass
- 793 Sepia Glass

QUICK VIEW



GS-791



GS-792

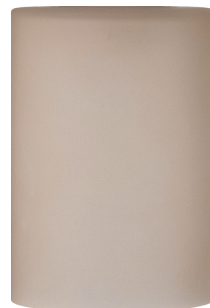

GS-793

