

# 86 Series (Cont.)

6" Reflectors/Trims Compatible with 8660, 8661, 8666, & 8667  
See more trim options on pages 133, 134, 135, 136, & 137.

RESIDENTIAL | RECESSED DOWNLIGHTS | 6" Diameter | 86 Series (Continued)

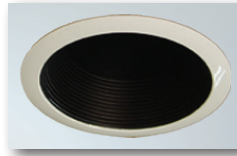
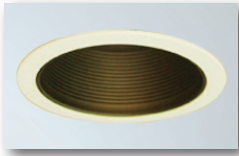

**8006-5 Black Metal Baffle**  
Non-IC  
150W PAR38/R40  
IC  
90W PAR30/R30

**8006-6 White Metal Baffle**  
Non-IC  
150W PAR38/R40  
IC  
90W PAR30/R30

**8007-5 Black Air Tight Cone Baffle**  
Non-IC/IC  
75W PAR38/R40

**8007-6 White Air Tight Cone Baffle**  
Non-IC/IC  
75W PAR38/R40

**8609-6 Fresnel Shower**  
Non-IC  
60W A19  
IC  
40W A19  
Wet location

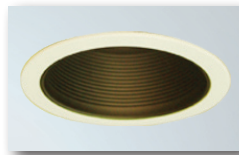
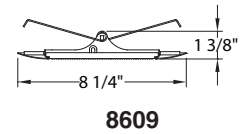
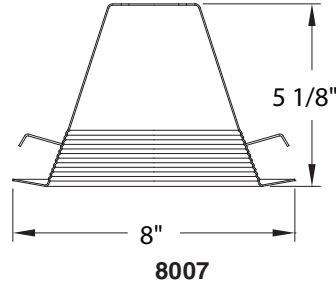
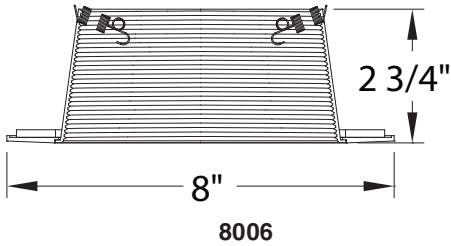

**8014-6 Eyeball**  
Non-IC  
75W PAR30/R30

**8015-6 Albalite Shower**  
Non-IC  
60W A19  
IC  
40W A19  
Wet location

**8016-5 Black Metal Baffle**  
Non-IC/IC  
75W PAR30/R30

**8016-6 White Metal Baffle**  
Non-IC/IC  
75W PAR30/R30

**8025-6 Open Trim**  
Non-IC/IC  
75W PAR30/R30

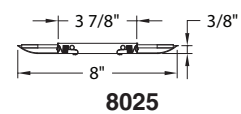
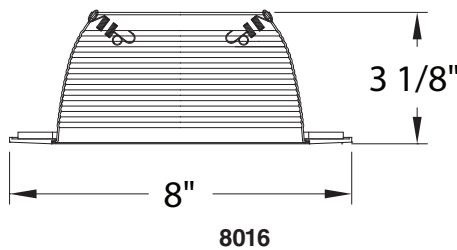
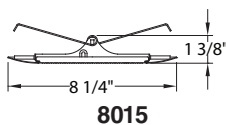
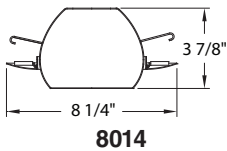

**8035-6 Open Trim**  
Non-IC  
150W PAR38/R40

**8613-3 Aluminum Cone Reflector**  
Non-IC  
100W A19  
IC  
60W A19

**8614-6 Drop Opal Lens Shower**  
Non-IC  
60W A19  
IC  
40W A19  
Wet location

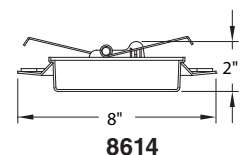
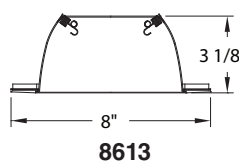
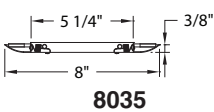

## 8660/8661

### 6" DIAMETER INCANDESCENT/LED RECESSED DOWNLIGHT

**RECESSED DOWNLIGHT MODEL**

- 8660 (IC) (90W)
- 8661 (NC) (150W)

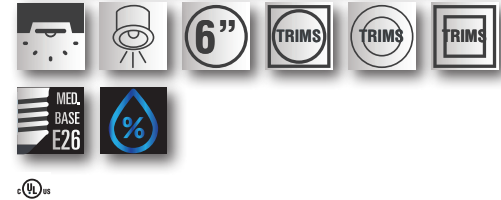

#### QUICK VIEW

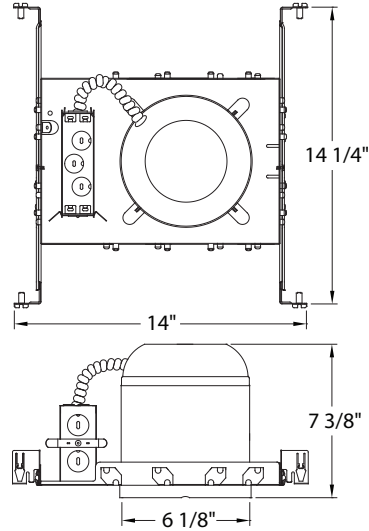

#### APPLICATIONS

##### NEW CONSTRUCTION,

##### COMMERCIAL, OR RESIDENTIAL:

- 8600
- 8661

##### COMMERCIAL OR RESIDENTIAL:

- 8666
- 8667

#### LIGHT SOURCES

##### LED/INCANDESCENT

##### COMPATIBILITY:

- LED
  - 8660 or 8667: 90 Watts Max
  - 8661 or 8666: 150 Watts Max
- Incandescent
  - 8660 or 8667: 90 Watts Max
  - 8661 or 8666: 150 Watts Max
- Lamps Sold Separately (Refer to Compatible Trims for Compatible Lamp Types and Sizes)

##### EDISON BASE LAMPHOLDER:

Medium Base (E26)

##### THERMAL MANAGEMENT: Passive

##### ADJUSTABLE SOCKET CUP:

Socket cup adjusts vertically.

#### COMPATIBLE TRIMS

##### FINISH/COLORS/TRIM:

- See Compatible Trims Page 132, Page 133, Page 134, Page 135, Page 136, and Page 137

#### INSTALLATION

##### CEILING:

- Accommodates Up to 1" Thickness
- 6 1/8" Ceiling Cutout Size
- 8661 or 8666
  - Non-Type IC: Insulation to Be Kept 3" Away
  - Non Air-Tight
- 8660 or 8667
  - Type IC: Suitable for Direct Contact with Insulation
  - Air-Tight

##### MOUNTING:

- 8660 or 8661
  - Adjustable Hanger Bars (14" to 24")
  - 7 1/2" Height Allows Use in 2" x 8" Joist Construction
- 8666 or 8667
  - Spring Clips Allow for Fast and Easy Installation
  - 7 1/2" Height Allows Use in 2" x 8" Joist Construction

##### J-BOX WIRING:

- 8660 or 8661
  - Integral Thru-Branch, 4 In/4 Out
- 8666 or 8667
  - Integral Thru-Branch, 2 In/2 Out

#### COMPLIANCES/WARRANTY

- cULus LISTED**
- SUITABLE FOR DAMP LOCATIONS**
- LED COMPATIBLE**
- RECESSED DOWNLIGHT**

#### QUICK VIEW

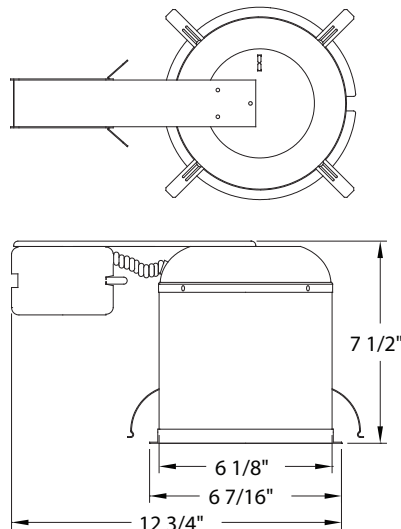

### 6" DIAMETER INCANDESCENT/LED RECESSED REMODEL

## 8666/8667

**REMODEL DOWNLIGHT MODEL**

- 8666 (NC) (150W)
- 8667 (IC) (90W)

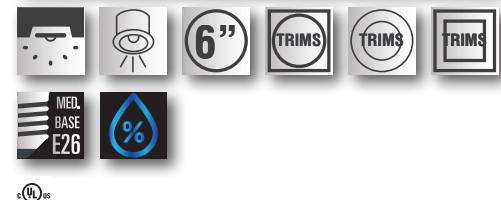

## APPLICATIONS

**NEW CONSTRUCTION,  
COMMERCIAL, OR RESIDENTIAL:**

- 8670

**COMMERCIAL OR RESIDENTIAL:**

- 8671

## LIGHT SOURCES

**LED/INCANDESCENT**

**COMPATIBILITY:**

- LED (75 Watts Max)
- Incandescent (75 Watts Max)
- Lamps Sold Separately (Refer to Compatible Trims for Compatible Lamp Types and Sizes)

**EDISON BASE LAMPHOLDER:**

Medium Base (E26)

**THERMAL MANAGEMENT:** Passive

## COMPATIBLE TRIMS

**FINISH/COLORS/TRIM:**

- See Compatible Trims Page 132, Page 133, Page 134, Page 135, Page 136, and Page 137

## INSTALLATION

**CEILING:**

- Type IC
  - Suitable for Direct Contact with Insulation

- 6 1/8" Ceiling Cutout Size





**MOUNTING:**

- **8670**
  - Adjustable Hanger Bars (14" to 24")
  - 5 1/2" Height Allows Use in 2" x 6" Joist Construction
- **8671**
  - Spring Clips Allow for Fast and Easy Installation
  - 5 1/2" Height Allows Use in 2" x 6" Joist Construction

**J-BOX WIRING:**

- **8670**
  - Integral Thru-Branch, 4 In/4 Out
- **8671**
  - Integral Thru-Branch, 2 In/2 Out

## COMPLIANCES/WARRANTY

-  **cULus LISTED**
-  **SUITABLE FOR DAMP LOCATIONS**
-  **LED COMPATIBLE**
-  **RECESSED DOWNLIGHT**

## 6" DIA. INCANDESCENT/LED SHALLOW HOUSING RECESSED DOWNLIGHT

### 8670

RECESSED  
DOWNLIGHT MODEL  8670



### QUICK VIEW

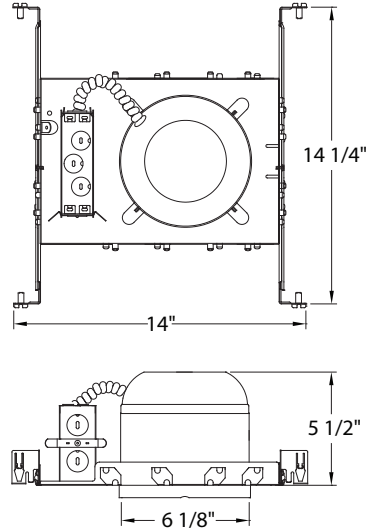

## 6" DIA. INCANDESCENT/LED SHALLOW HOUSING RECESSED REMODEL

### 8671

REMODEL  
DOWNLIGHT MODEL  8671



### QUICK VIEW

