

LED LIGHT ENGINE

WATTS/LUMENS:

- **TL116:** 6W/470 lm
- **TL120:** 9W/790 lm
- **TL130:** 12W/1000 lm
- **TL138:** 18W/1500 lm

CR/CCT: 80/3000K

BINNING: 3 SDCM

THERMAL MANAGEMENT: Passive

LIFE (RATED):

50,000 hours based on LED testing per LM80-08 and projected values from IESNA TM21-11.

OPTICS

BEAM ANGLES: 30°

ADJUSTABLE/HORIZONTAL

AIMING: Up to 90° tilt from vertical axis and up to 355° rotation around vertical axis.

DESIGN:

Unique Integral Construction

FINISH/COLORS: Anodized (Clear)

PRODUCTION PROCESS:

CNC Precision-Spun

MATERIAL: Specification-Grade Aluminum Alloy, .060" Thick

CONSTRUCTION

HOUSING:

Die-Formed Fabrication

FINISH/COLORS:

- Powdercoat Paint Colors (3)
 - Black (BK)
 - White (WH)
 - Silver Gray (SL)

INSTALLATION

MOUNTING:

- Mounts to 120V AC *QuantaLight* Track Systems
 - TSQ1: 1-Circuit/1-Neutral (1C1N)
 - TSQ2: 2-Circuit/1-Neutral (2C1N)
- Mounts to 1-Circuit or 2-Circuit Track System Platforms

ADAPTERS: Listed Components

LED DRIVER

OUTPUT POWER SUPPLY: Class II

POWER FACTOR (P_f): >.9



THD: <20%

INPUT VOLTAGE: 120V at 50/60 Hz (System Adapter Dependant)



DIMMING: TRIAC/ELV 5% dimmable on the input primary, line-side circuit of the track system. Consult dimmer manufacturer for compatibility and conditions of use.

COMPLIANCES/WARRANTY

 **cETLus LISTED**
 **ENERGY STAR (CONSULT FACTORY)**

 **FCC COMPLIANT**
 **5-YEAR LIMITED WARRANTY**

 **RoHS COMPLIANT**
 **ENERGY-EFFICIENT**

 **LED**
 **DRY LOCATIONS ONLY**

TL116/TL120

LED TRACK HEADS









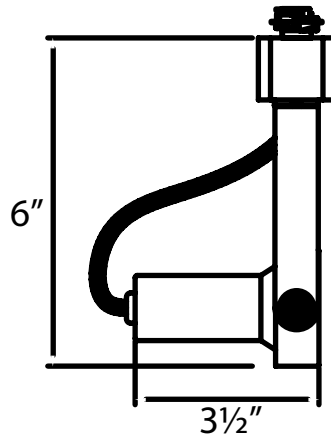







TL116

- | | |
|-------------------------|---|
| TRACK HEAD MODEL | <input checked="" type="checkbox"/> TL116 |
| TRACK ADAPTER | <input checked="" type="checkbox"/> Q2 1C1N & 2C1N (120V) |
| CCT | <input checked="" type="checkbox"/> 30 3000K |
| LUMENS | <input checked="" type="checkbox"/> 05 470 lm |
| OPTICS | <input checked="" type="checkbox"/> 30 30° |
| FINISH | <input type="checkbox"/> 5 Black (Painted)
<input type="checkbox"/> 6 White (Painted)
<input type="checkbox"/> 20 Silver Gray (Painted) |



QUICK VIEW



					
					
					
					









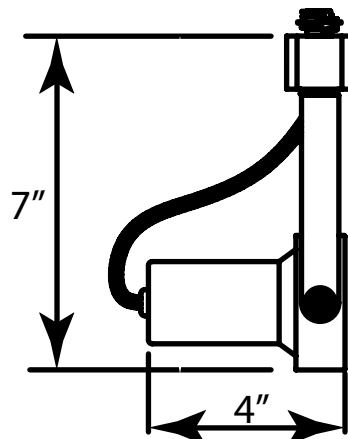







TL120

- | | |
|-------------------------|---|
| TRACK HEAD MODEL | <input checked="" type="checkbox"/> TL120 |
| TRACK ADAPTER | <input checked="" type="checkbox"/> Q2 1C1N & 2C1N (120V) |
| CCT | <input checked="" type="checkbox"/> 30 3000K |
| LUMENS | <input checked="" type="checkbox"/> 08 790 lm |
| OPTICS | <input checked="" type="checkbox"/> 30 30° |
| FINISH | <input type="checkbox"/> 5 Black (Painted)
<input type="checkbox"/> 6 White (Painted)
<input type="checkbox"/> 20 Silver Gray (Painted) |



QUICK VIEW



LED LIGHT ENGINE

WATTS/LUMENS:

- **TL116:** 6W/470 lm
- **TL120:** 9W/790 lm
- **TL130:** 12W/1000 lm
- **TL138:** 18W/1500 lm

CR/CCCT: 80/3000K

BINNING: 3 SDCM

THERMAL MANAGEMENT: Passive

LIFE (RATED):

50,000 hours based on LED testing per LM80-08 and projected values from IESNA TM21-11.

OPTICS

BEAM ANGLES: 30°

ADJUSTABLE/HORIZONTAL

AIMING: Up to 90° tilt from vertical axis and up to 355° rotation around vertical axis.

DESIGN:

Unique Integral Construction

FINISH/COLORS: Anodized (Clear)

PRODUCTION PROCESS:

CNC Precision-Spun

MATERIAL: Specification-Grade Aluminum Alloy, .060" Thick

CONSTRUCTION

HOUSING:

Die-Formed Fabrication

FINISH/COLORS:

- Powdercoat Paint Colors (3)
 - Black (BK)
 - White (WH)
 - Silver Gray (SL)

INSTALLATION

MOUNTING:

- Mounts to 120V AC *QuantaLight* Track Systems
 - TSQ1: 1-Circuit/1-Neutral (1C1N)
 - TSQ2: 2-Circuit/1-Neutral (2C1N)

- Mounts to 1-Circuit or 2-Circuit Track System Platforms

ADAPTERS: Listed Components

LED DRIVER

OUTPUT POWER SUPPLY: Class II

POWER FACTOR (Pf): >.9

THD: <20%

INPUT VOLTAGE: 120V at 50/60 Hz (System Adapter Dependant)

DIMMING: TRIAC/ELV 5% dimmable on the input primary, line-side circuit of the track system. Consult dimmer manufacturer for compatibility and conditions of use.

COMPLIANCES/WARRANTY

 **cETLus LISTED**

 **ENERGY STAR (CONSULT FACTORY)**

 **FCC COMPLIANT**

 **5-YEAR LIMITED WARRANTY**

 **RoHS COMPLIANT**

 **ENERGY-EFFICIENT**

 **LED**

 **DRY LOCATIONS ONLY**

TRACK HEAD MODEL TL130

TRACK ADAPTER Q2 1C1N & 2C1N (120V)

CCT 30 3000K

LUMENS 10 1000 lm

OPTICS 30 30°

FINISH 5 Black (Painted)

6 White (Painted)

20 Silver Gray (Painted)

QUICK VIEW

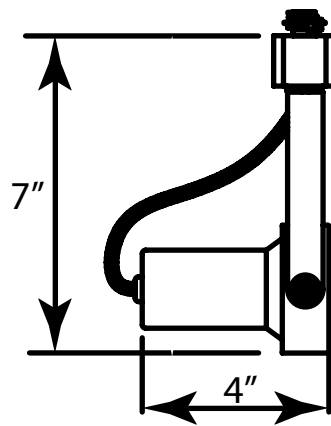

TL130/TL138

LED TRACK HEADS

TL130

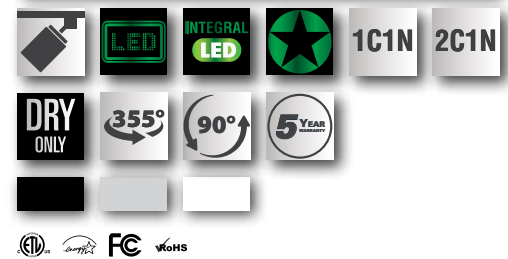

TL138

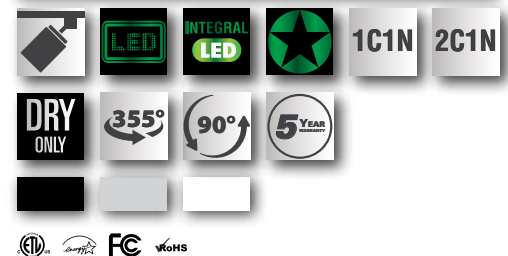

QUICK VIEW

